

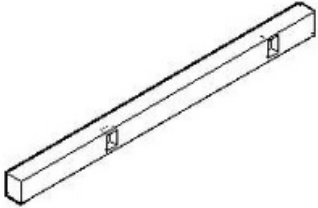

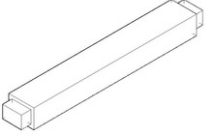

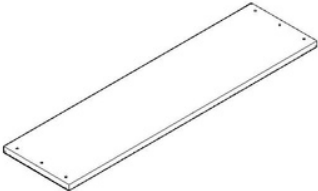
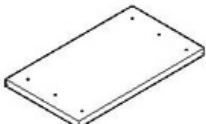
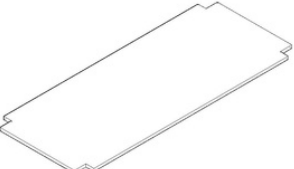

Montageanleitung

Hochbeet mit Rankgitter aus Metall H4H267

A*4 	B*2 	C*2 
D*2 	E*2 	F*1 
G*1 	H*2 	I*28  M4*30
J*12  M4*18	K*2 	

①

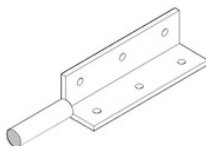
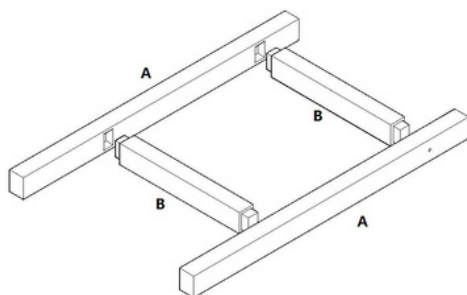

②

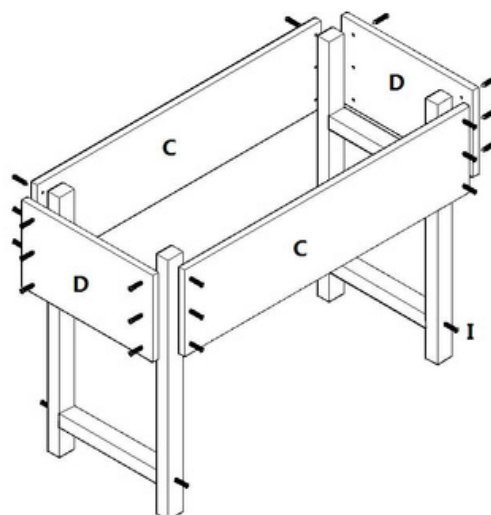





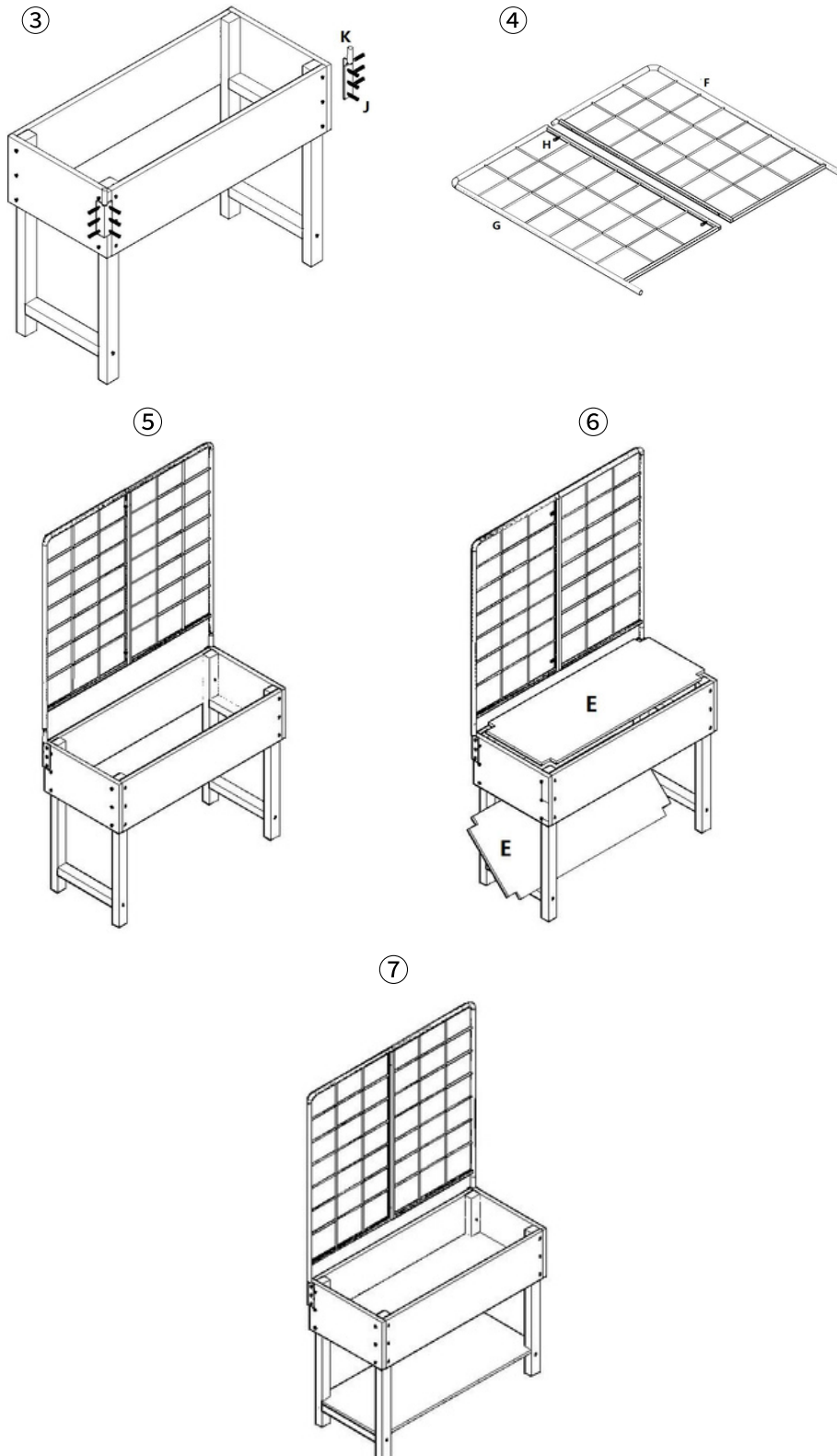

Montageanleitung

Hochbeet mit Rankgitter aus Metall H4H267

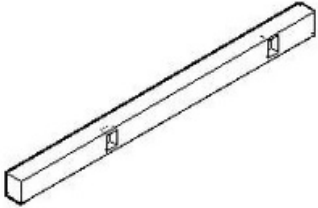
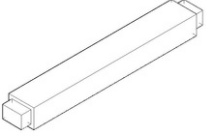
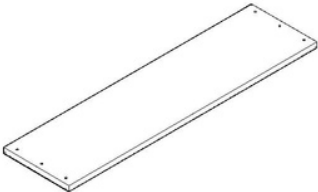
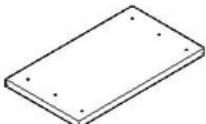
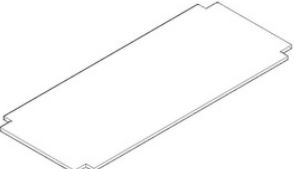

Assembly Instruction

Raised bed with metal trellis H4H267

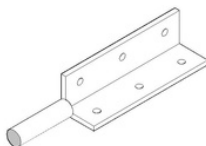
A*4 	B*2 	C*2 
D*2 	E*2 	F*1 
G*1 	H*2 	I*28  M4*30
J*12  M4*18	K*2 	

①

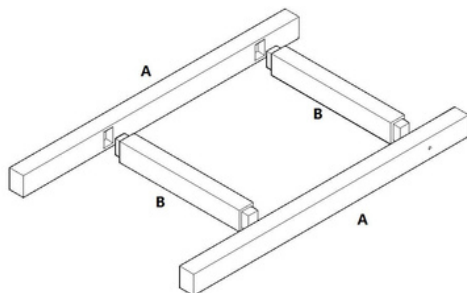

②

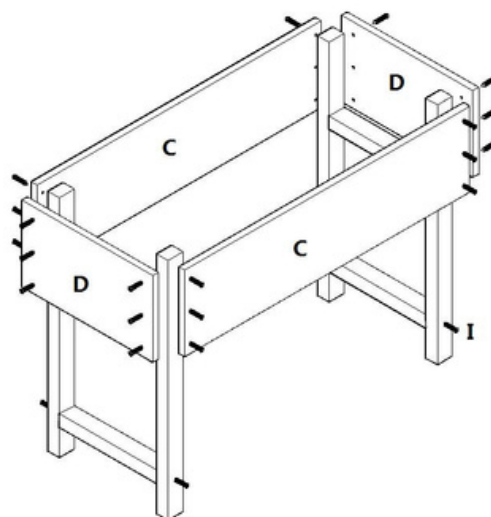

Assembly Instruction

Raised bed with metal trellis H4H267

